

## The use of dimethyl ether (DME) solution in compression ignition engine

### ARTICLE INFO

Received: 16 January 2024  
Revised: 8 March 2024  
Accepted: 17 May 2024  
Available online: 27 May 2024

*The development of compression ignition combustion engines is focused on meeting many challenges, mainly related to growing ecological requirements. Currently, however, due to technological barriers, meeting them is very difficult and requires the use of additional exhaust gas treatment systems. The use of injection of a diesel and gas solution seems to be very promising. The article presents the results of engine tests involving the use of a solution of diesel fuel and dimethyl ether. The tests were performed on a single-cylinder research engine equipped with a common rail fuel system. The obtained results suggest that the use of the solution has a positive effect on the process of creating the fuel-air mixture, resulting in a reduction in the concentration of HC and CO while increasing the share of NO<sub>x</sub>, suggesting an improvement in the combustion process, as evidenced by the limiting injection dose.*

Key words: *dimethyl ether, diesel solutions, exhaust emissions, ecology, alternative fuels*

This is an open access article under the CC BY license (<http://creativecommons.org/licenses/by/4.0/>)

### 1. Introduction

Since its introduction to the market in the 1930s, diesel engines have gained wide recognition in the automotive world. Their growing popularity resulted not only from their high efficiency but also from their ability to generate a significant amount of torque at low rpm, which affects fuel economy and their durability. These engines played a key role in passenger cars, heavy-duty vehicles, buses, and even locomotives or ships, despite the fast evolution of electric motors and battery technology [14].

Initially, diesel engines were the most popular in the commercial vehicle sector due to their excellent economic properties [17]. However, over time, the technology has found a widespread use in passenger cars, since drivers expect engine efficacy balanced with fuel efficiency. As a result, for many years, diesel engines dominated the automotive market, gaining loyal supporters around the world.

With the rising popularity, diesel engines also gained some opponents. In recent years, especially in the context of growing environmental awareness and concern for the environment, these engines have come under fire due to the emission of harmful substances such as nitrogen oxides (NO<sub>x</sub>) and particulate matter (PM) [11, 12]. More and more stringent requirements were set for exhaust emission standards, which forced the use of technologically advanced exhaust gas cleaning systems based on particulate filters, multi-level exhaust gas recirculation systems, or selective catalytic reduction (SCR) systems [15, 16].

One of the most effective ways to reduce exhaust emissions is to improve the fuel atomization process, which results in a more homogeneous fuel-air mixture and allows for better control of the combustion process. The currently used injection systems generate a fuel pressure of up to 2500 bar, which allows the atomization of the injection dose into up to 8 parts. Further, atomization by increasing the pressure of the injected fuel is becoming more and more difficult to achieve due to technological limitations and the strength of the materials.

One way to improve fuel atomization may be to create a solution of gas in the fuel. The concept involves supplying a certain amount of gas to the fuel, which is then dissolved in it; the pressure generated by the high-pressure pump causes the fuel in the reservoir and injection lines to remain in equilibrium. During the next stage occurring when the injector is opened, an effect is observed that accompanies the release of dissolved gas from the liquid fuel during injection into the combustion chamber (desorption effect), which occurs due to a strong imbalance. This phenomenon is due to the characteristics of this solution – when the pressure is lowered, the excess gas dissolved in the liquid is spontaneously released simultaneously from the entire volume. The decrease in pressure is accompanied by a decrease in the equilibrium thermodynamic potential. Thus, the negative pressure gradient is the thermodynamic stimulus that causes the release of gas from the solution. The rate of gas release is related to the rate of change of the stimulus. The goal of the proposed concept is to achieve better fuel injection, at least qualitatively, compared to that obtained in high-pressure systems while maintaining relatively low injection pressures.

Most gases dissolve poorly in liquids, and the amount of gas dissolved strongly depends on the pressure and temperature at which dissolution occurs. Gas atoms (or molecules) in the solution state are uniformly dispersed throughout the liquid volume. Releasing simultaneously throughout the volume, the molecules form dispersed microbubbles, expand, and tend to merge. As a result, the volume is divided into two parts: one – is occupied by solution and the other – by gas. However, if the pressure drop occurs dynamically, then the microbubbles will not manage to merge into a single volume. A factor that promotes the intensification of the effect of desorption of gas from the solution is, therefore, the speed of the process. This is beneficial for the engine. There is a significant pressure difference between the atomizer from which the fuel flows and the combustion chamber through which the fuel passes. The fuel flows out

over a short distance (the length of the atomizer channels) and in a very short time. The simultaneous combination of these factors means a very high rate of pressure change during injection and, thus, a very large thermodynamic potential gradient. Thus, if a fuel-gas solution is injected into the injector, we note that during the outflow of fuel through the atomizer orifices, there is a dynamic release of gas in the fuel due to a rapid drop in the thermodynamic potential in the outlet path. This mechanism causes the fuel droplets to burst from the center. Thus, it will be an additional factor supporting the existing fuel atomization mechanism.

According to the concept presented, in the high-pressure part of the injection system (from the high-pressure pump up to the atomizer ports), the pressure should be maintained at such a level that the gas cannot escape from the solution. In this part of the system, the fuel with gas should form a homogeneous solution. Gas release coupled with expansion should take place only outside the atomizer to help break up droplets along the fuel outlet. This process is qualitatively illustrated in Fig. 1 [4].

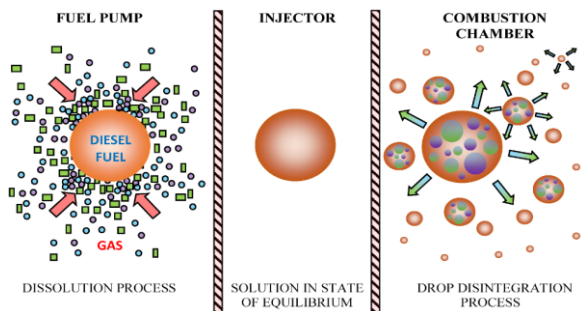

Fig. 1. Spray mechanism of gas dissolved from fuel

Various gases dissolved in diesel fuel have been studied so far, but dimethyl ether seems to be one of the most very promising. Owing to its properties (very good solubility and high cetane number), it is also suitable for diesel engines as a stand-alone fuel [10].

The use of dimethyl ether as a fuel to power compression ignition engines has many benefits. DME has physico-chemical parameters similar to conventional diesel fuel. A comparison of the most important parameters is presented in Table 1.

A very important aspect supporting the wider use of dimethyl ether as a fuel is the fact that it belongs to the group of second-generation alternative fuels. DME production technology is based, among others, on biomass gasification, which makes it possible to increase independence from fossil fuels [2].

The basic parameters that determine whether the fuel is suitable for powering compression ignition engines include the self-ignition temperature and the cetane number. In both cases, the alternative fuel is characterized by more favorable values. The self-ignition temperature is lower by 15 degrees Celsius, thanks to which the fuel allows for easier starting of the engine at lower temperatures, while the cetane number is, on average, several points higher than in the case of conventional diesel fuel. Both of these parameters make the DME in the compression ignition engine ignite

more easily than in the case of conventional diesel fuel. Another preferred parameter is a low boiling point, which is 25 degrees Celsius. DME occurs in atmospheric conditions in the gaseous form. Therefore, it has to be stored in the liquefied form. Its density is lower than that of conventional diesel fuel. In addition, it has an oxygen atom in its molecule, which means that its calorific value is lower than that of conventional diesel fuel. This requires the use of larger tanks to ensure the same operating time as for the conventional diesel fuel motor power supply [18, 19].

Table 1. Comparison of dimethyl ether and diesel characteristics [5, 7, 13]

| Parameter                        | Unit              | Dimethyl ether                     | Diesel oil |
|----------------------------------|-------------------|------------------------------------|------------|
| Critical pressure                | MPa               | 5.37                               | 3.00       |
| Lower calorific value            | MJ/kg             | 27.6                               | 39.5       |
| Lower explosion limit            | % vol.            | 3.2                                | 0.6        |
| Liquid density                   | kg/m <sup>3</sup> | 667                                | 842.5      |
| Upper explosion limit            | % vol.            | 18                                 | 7          |
| Kinematic viscosity of liquid    | cSt               | < 0.1                              | 3          |
| Cetane index                     |                   | 57                                 | 51         |
| Molar mass                       | g/mol             | 46                                 | 170        |
| Surface tension                  | N/m               | 0.012                              | 0.027      |
| Vapor pressure                   | kPa               | 530                                | << 10      |
| C/H ratio                        |                   | 0.337                              | 0.516      |
| Stoichiometric ratio of air/fuel |                   | 9                                  | 14.6       |
| Chemical structure               |                   | CH <sub>3</sub> -O-CH <sub>3</sub> | -          |
| Critical temperature             | °C                | 126                                | 434        |
| Self-ignition temperature        | °C                | 234                                | 249        |
| Boiling point at 1 atm           | °C                | -25                                | 176-370    |
| Oxygen content                   | % mass            | 34.8                               | 0          |
| Carbon content                   | % mass            | 52.2                               | 86,5       |
| Hydrogen content                 | % mass            | 13                                 | 13.4       |

The challenge in the widespread use of dimethyl ether as the main fuel for powering diesel engines is its low lubricity and viscosity. These parameters have a significant impact on the operation of injection systems, as they are responsible for creating a lubricating film that prevents from the wear of engine parts. Due to their low value, the production of insufficient thickness of the lubricating film leads to faster wear of engine parts. These properties disqualify the use of pure DME. The problem of low lubricity can be solved by using additives to increase lubricity. DME dissolves very well in conventional diesel fuel therefore it is very promising as an additive to conventional diesel fuel. Thanks to DME physical properties, it can be used to create a solution, and thus obtain a release effect.

A very important issue from the point of view of environmental impact is that dimethyl ether can be produced from renewable substances. One of the methods of obtaining DME is the gasification of biomass such as wood, agricultural waste, or biological residues. The biomass is subjected to a pyrolysis process, which produces synthesis gas. Then, using appropriate catalysts based on copper and zinc compounds, methanol is synthesized, which is then transformed into dimethyl ether in the next step. Producing DME from renewable raw materials is undoubtedly the most ecological, but due to the economic aspects and efficiency of the process, it is currently most often produced from natural gas rich in methane in the steam reforming

process. Due to the fact that the combustion of DME in a compression ignition engine results in a reduction in emissions of toxic compounds contained in the fuel [8], it is reasonable to examine the impact of DME as a fuel additive with its release effect on engine operating parameters and emissions.

## 2. Preparation of the test stand

Due to the fact that dimethyl ether is a gaseous fuel, it is necessary to prepare a suitable system for storing it and supplying it to the high-pressure pump [3].

Preparing an injection system that allows gases to dissolve is a big challenge due to the differences in compressibility of both components and the presence of different phases of concentration. For this purpose, a high-pressure pump equipped with a special pumping section (Fig. 2) was used, which allows gas to be supplied and mixed with fuel during stacking.

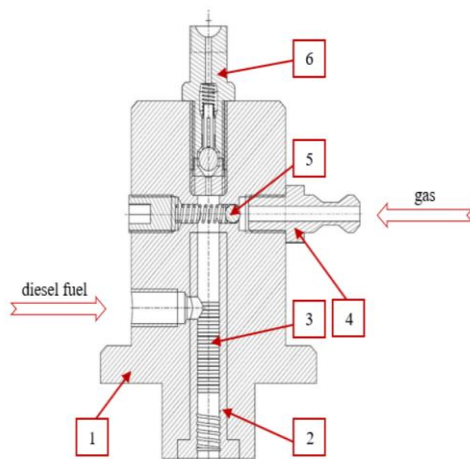

Fig. 2. Delivery section of pump: 1 – body of the delivery section, 2 – cylinder, 3 – section labyrinth seal, 4 – gas stub pipe, 5 – one-way gas valve, 6 – one-way outlet valve [4, 6]

The fuel pump is driven by an independent system consisting of an electric motor controlled by an inverter. The rotational speed is adjusted in such a way as to ensure adequate pressure and output of the pumped fuel while it is overheating since it may affect the measurement results.

Diesel fuel is supplied to the pump at a pressure of 5 bar generated by the initial fuel pump, while gaseous fuel, due to the fact that it is stored in a pressurized cylinder, is supplied to the system directly using a conditioning system equipped with a filter unit and a pressure regulator to control the amount of dissolved gas. For the first series of measurements, standard Bosch CP3 high-pressure fuel pump was used. During the second measurement series, where the solution was created, a special pump was used to dissolve the gas in place of the standard CR pump.

The concentration of dissolved gas in the fuel obtained in this way is difficult to determine precisely; however, under fixed operating conditions of the engine (i.e. constant rotational speed and constant load) it remains at an even level, depending on the pressure at which it is supplied to the high-pressure pump.

The tests were carried out on a motor dynamometer equipped with a single-cylinder SB3.1 test engine coupled

with an electric swirl brake. The basic parameters of the test engine are presented in Table 2.

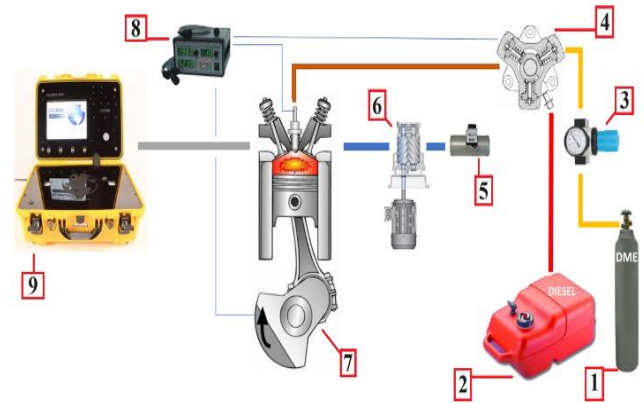

Fig. 3. Engine test bench: 1 – DME tank, 2 – diesel tank, 3 – filtration block with pressure regulator, 4 – fuel pump/modified fuel pump, 5 – mass air flow meter, 6 – inlet air compressor, 7 – SB 3.1 engine, 8 – injection controller, 9 – exhaust gases analyzer

Table 2. Tested engine parameters

|                             |                       |
|-----------------------------|-----------------------|
| Cylinder diameter           | 127 mm                |
| Stroke                      | 146 mm                |
| Displacement                | 1.850 dm <sup>3</sup> |
| Compression ratio           | 15.75                 |
| Crank ratio                 | 0.263                 |
| Connecting rod length       | 277 mm                |
| Inlet valve opening angle   | 4° before TDC         |
| Inlet valve closing angle   | 57° after BDC         |
| Exhaust valve opening angle | 42° before BDC        |
| Exhaust valve closing angle | 24° after TDC         |

## 3. Methods

The measuring devices and test equipment mentioned in the previous section were selected to carry out the tests due to the scope of work adequate to the expected results. Exhaust gases for the Axion analyzer were collected directly from the exhaust system using dedicated, leakless holes. In accordance with current engine testing practices, measurements began after the engine warm-up phase, when the temperature of the coolant and oil had stabilized.

Tests were planned to be carried out for 900 rpm. Characteristics were performed covering 6 measurement points in the load range from 0 to 50 nm. The tests began with no-load operation, then the brake torque was increased by 10 nm and the injection time was adjusted to achieve the selected operating points.

The start of the injection angle was set up by a dedicated controller that triggered a signal controlling the power amplifier supplying the injector coil. The controller uses a signal from an absolute encoder with a resolution of 8 bits, which, due to limited availability, was mounted on the camshaft. The mounting method and resolution of the encoder allow the injection angle to be adjusted by exactly 2.8125 degrees. Adjustment of the injection time was carried out with an accuracy of 0.1 ms.

During the research, three measurement series were performed. The first for a conventional injection system equipped with a standard Bosch CP3 pump, which serves as

a reference point for further measurements. The next two tests were carried out using a dedicated high-pressure pump, enabling the dissolution of gases. Dimethyl ether was fed to a high-pressure pump equipped with a modified pumping section, enabling the dissolution of gases at pressures of 3 and 5 bar. The DME supply pressure was changed using a pressure regulator block and was controlled before the start of each series of measurements. Adjusting the dimethyl ether supply pressure allows you to control the amount of gas dissolved in the diesel fuel. Increasing the DME supply pressure changes the amount of gas in the solution. Therefore, in order to determine the impact on the concentration of harmful exhaust gas components, tests were carried out for two values of DME supply pressure (3 bar and 5 bar).

The fuel pressure during the measurements was regulated by an external controller based on the reading from the pressure sensor in the CR tank and regulating the operation of the electronic fuel dose valve on the pump and the pressure regulator on the Common Rail tank. In order to demonstrate the favorable features of gas dissolution in the fuel, the injection pressure in each measurement series was 40 MPa.

#### 4. Results

Measurements of the concentration of gaseous components of exhaust gases were carried out after the engine reached the nominal operating temperature. The achievement of this state was determined on the basis of the temperature of the oil and the cooling liquid. The effects of using a mixture of diesel oil and dimethyl ether to power the test engine could already be observed in the case of idling, which manifested itself in the need to reduce the injection time in order to achieve the same rotational speed as the common rail. The trend shown in Fig. 4 is also noticeable for other load values.

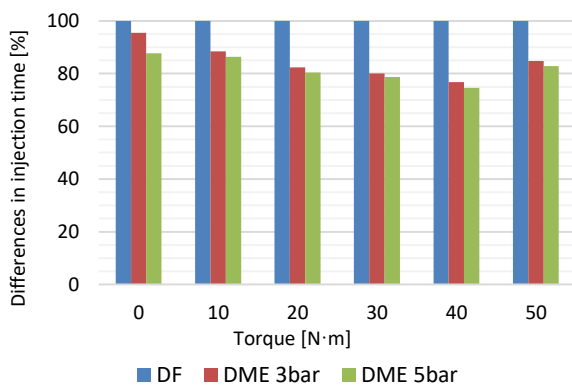

Fig. 4. Comparison of injection time for diesel and DME solutions

The comparison of carbon monoxide concentration as the percentage proportion is shown in Fig. 5. The gas-fuel solution reduces the concentration compared to conventional fuel. The share of DME in the solution can be increased by increasing the pressure of delivering it to the pump. The higher the DME share in the solution, the more noticeable the reduction of carbon monoxide concentration is.

Figure 6 shows a comparison of hydrocarbon concentrations. A significant reduction in the concentration of toxic compounds is already observed at idling speed. At the analyzed engine operating point, the use of the solution reduces hydrocarbon concentration by about 60%. As the load increases, the difference in hydrocarbon concentration becomes even more apparent. At the maximum load, the HC concentration in the case of the gas-fuel solution (for 5 bar DME) is only 10% of the concentration that was measured when feeding the engine purely with conventional fuel.

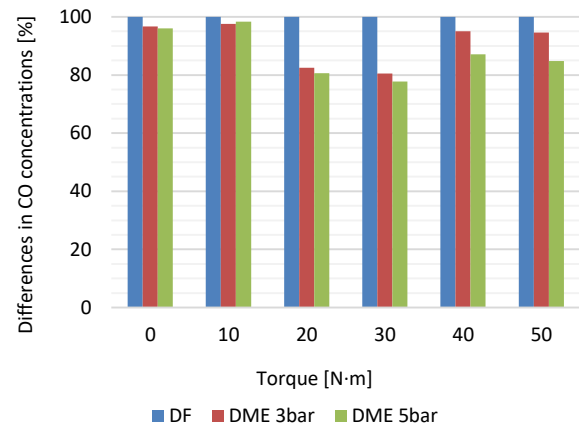

Fig. 5. Comparison of CO concentration for diesel and DME solutions

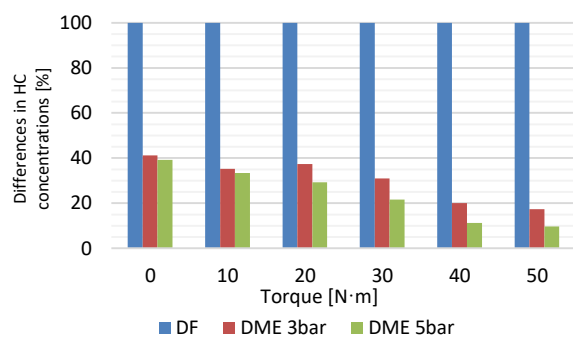

Fig. 6. Comparison of HC concentration for diesel and DME solutions

Should the improvement of the atomization structure be solely accounted for the reduction in PM and HC when the engine was supplied with a solution, an increase in  $\text{NO}_x$  concentration in exhaust gases is predicted. The results of  $\text{NO}_x$  measurements presented in Fig. 7. clearly confirm this prediction. An increase in  $\text{NO}_x$  concentration was noted at almost all measurement points. The  $\text{NO}_x$  emissions significantly increase together with the increasing amount of dissolved air, especially within the range of low engine speed.

#### 5. Summary

Dimethyl ether, due to its properties similar to diesel fuel, is an ideal fuel for powering compression-ignition engines. However, as of today, technological problems resulting from its low lubricity, viscosity, and energy value remain to be solved. Therefore, the use of DME as an independent fuel is difficult to implement.



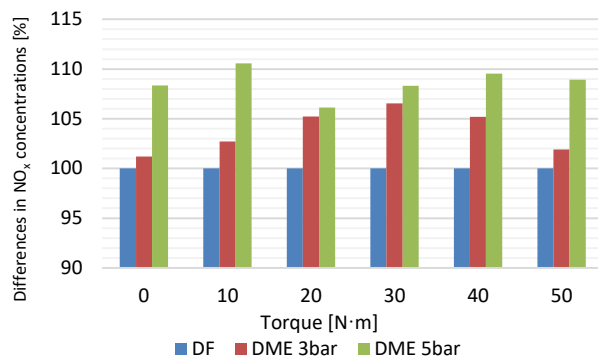

Fig. 7. Comparison of NO<sub>x</sub> concentration for diesel and DME solutions

Dissolving the gas in the diesel fuel creates an equilibrium mixture by maintaining high pressure. At the moment of injection, when the pressure drops, gas molecules are released from the solution. The obtained research results indicate that the occurrence of this phenomenon significantly affects the combustion process and the concentration of harmful compounds in the exhaust gases. Although the use of DME as a fuel in a diesel engine is characterized by a reduction in NO<sub>x</sub> emissions (mainly as a result of lowering the maximum combustion temperature), by using a solution of a small amount of gas and its release at the time of injection, an increase in the concentration of these compounds is observed due to the improvement of the atomization mechanism and the combustion process.

Feeding the engine with the solution has a significant impact on reducing the concentration of hydrocarbons in exhaust gases. The observed results prove the improvement of the fuel evaporation process and the improvement of the process of creating the fuel-air mixture, which becomes more homogeneous throughout the entire volume of the combustion chamber.

These studies also show that in order to perform measurements at the same engine operating points (constant rotational speed and load), it is necessary to shorten the injector opening time when fueled with a gas and diesel solution. It should be noted that all tests were performed at the same injection pressure of 40 MPa. It is worth empha-

sizing that the indicated fuel pressure value is too low to ensure sufficient fuel atomization in the case of diesel fuel.

The dissolution of DME in diesel fuel, enabled by the use of a specially designed fuel pump, improves the process of creating the fuel-air mixture despite maintaining the same relatively low injection pressure. This mixture has a positive effect on the combustion process from an environmental and useful perspective by increasing the generated torque.

The presented test results and their analysis show that adding dimethyl ether to diesel in a high-pressure pump equipped with a special forcing section allows for the creation of a solution that remains in a state of equilibrium until it flows out of the atomizer when the dose is injected into the cylinder. Therefore, there is a phenomenon of dynamic release of DME bubbles from the solution, which causes the fuel droplets to burst from the inside.

We can also observe that increasing the gas pressure supplied to the pump, thereby increasing the concentration of dimethyl ether in the solution, results in an even greater reduction in the concentration of HC and CO and an increase in the NO<sub>x</sub> concentration. It can therefore be concluded that the higher the gas concentration in the solution, the more intense the desorption phenomenon occurs, significantly improving atomization.

Taking into account that currently, in order to meet increasingly stringent exhaust emission standards, it is necessary to use injection systems generating pressure exceeding 250 MPa, the use of a solution of dimethyl ether and diesel oil may be an interesting alternative to further increasing the pressure, which creates more and more technological problems, negatively affecting on the durability and reliability of engines.

It should be expected that the improvement of fuel atomization, the effects of which are observed in the presented results of concentrations of gaseous components of exhaust gases, will also affect the mass and number of generated particulate matter. Therefore, further directions of research will include determining the impact of the use of a solution of dimethyl ether with diesel fuel on the amount and mass, and size distribution of particle matter.

## Nomenclature

BDC bottom death center  
 CO carbon oxide  
 CR common rail  
 DF diesel fuel  
 DME dimethyl ether  
 HC hydrocarbons

NDIR nondispersive infrared  
 NO<sub>x</sub> nitro oxides  
 PM particulate matter  
 SCR selective catalytic reduction  
 TDC top death center

## Bibliography

- [1] Arcoumanis C, Bae C, Crookes R, Kinoshita E. The potential of di-methyl ether (DME) as an alternative fuel for compression-ignition engines: a review. *Fuel*. 2007;87(7):1014-1030. <https://doi.org/10.1016/j.fuel.2007.06.007>
- [2] Azizi Z, Rezaeimaneshb M, Tohidiana T, Rahimpour MR. Dimethyl ether: a review of technologies and production challenges. *Chem Eng Process*. 2014;82:150-172. <https://doi.org/10.1016/j.cep.2014.06.007>
- [3] Bajerlein M, Bor M, Karpiuk W, Smolec R, Spadło M. Strength analysis of critical components of high-pressure fuel pump with hypocycloid drive. *Bull Pol Acad Sci-Tech*. 2020;68:1341-1350. <https://doi.org/10.24425/bpasts.2020.135380>
- [4] Bajerlein M, Karpiuk W, Smolec R. Use of gas desorption effect in injection systems of diesel engines. *Energies*. 2021; 14:244. <https://doi.org/10.3390/en14010244>

- [5] Bhide S, Morris D, Leroux J, Wain KS, Perez JM, Boehman AL. Characterization of the viscosity of blends of dimethyl ether with various fuels and additives. *Energy&Fuels*. 2003; 17(5):1126-1132. <https://doi.org/10.1021/ef030055x>
- [6] Bor M, Borowczyk T, Karpiuk W, Smolec R, Spadło M. Concept of a pump for diesel engines fuel supply using hypocycloid drive. *IOP Conf Ser: Mater Sci Eng*. 2018;421: 042034. <https://doi.org/10.1088/1757-899X/421/4/042034>
- [7] Lee D, Lee CS. Effects of DME-isobutane blended fuels on combustion and emissions reduction in a passenger car diesel engine. *J Energ Eng*. 2017;143(4). [https://doi.org/10.1061/\(ASCE\)EY.1943-7897.0000428](https://doi.org/10.1061/(ASCE)EY.1943-7897.0000428)
- [8] Karpiuk W, Smolec R, Idzior M. DME use in self-ignition engines equipped with common rail injection systems. 2016 International Conference on Sustainable Energy, Environment and Information Engineering (SEEIE 2016). 2016:37-43. <https://doi.org/10.12783/dteees/seeie2016/4494>
- [9] Kozak M. Exhaust emissions from a diesel passenger car fuelled with a diesel fuel-butanol blend. *SAE Technical Paper 2011-28-0017*. 2011. <https://doi.org/10.4271/2011-28-0017>
- [10] Kozak M, Merkisz J. Oxygenated diesel fuels and their effect on PM emissions. *Appl Sci*. 2022;12(15):7709. <https://doi.org/10.3390/app12157709>
- [11] Jaworski A, Mądziel M, Kuszewski H, Lejda K, Jaremcio M, Balawender K et al. The impact of driving resistances on the emission of exhaust pollutants from vehicles with the spark ignition engine fuelled with petrol and LPG. *SAE Technical Paper 2020-01-2206*. 2020. <https://doi.org/10.4271/2020-01-2206>
- [12] Jedliński Ł, Caban J, Krzywonos L, Wierzbicki S, Brumerčik F. Application of the vibration signal in the diagnosis of the valve clearance of an internal combustion engine. *J Vibroeng*. 2015;17(1):175-187. <https://www.extrica.com/article/15446>
- [13] Paliwa do pojazdów samochodowych. Oleje napędowe. Wymagania i metody badań. PN-EN 590:2022-08 (in Polish).
- [14] Pięłowska M, Kurc B, Galiński M, Fuć P, Kamińska M, Szymlet M et al. Challenges of safe electrolytes applied in lithium-ion cells – a review. *Materials*. 2021;14(22):6783. <https://doi.org/10.3390/ma14226783>
- [15] Rymaniak Ł, Kamińska M, Szymlet N, Grzeszczyk R. Analysis of harmful exhaust gas concentrations in cloud behind a vehicle with a spark ignition engine. *Energies*. 2021;14(6): 1769. <https://doi.org/10.3390/en14061769>
- [16] Rymaniak Ł, Merkisz J, Szymlet N, Kamińska M, Weymann S. Use of emission indicators related to CO<sub>2</sub> emissions in the ecological assessment of an agricultural tractor. *Eksploat Niezawodn*. 2021;23(4):605-611. <https://doi.org/10.17531/ein.2021.4.2>
- [17] Sawczuk W, Merkisz-Guranowska A, Rilo Cañas AM, Kołodziejcki S. New approach to brake pad wear modelling based on test stand friction-mechanical investigations *Eksploat Niezawodn*. 2022;24(3):419-426. <https://doi.org/10.17531/ein.2022.3.3>
- [18] Smolec R, Idzior M, Karpiuk W, Kozak M. Assessment of the potential of dimethyl ether as an alternative fuel for compression ignition engines. *Combustion Engines*. 2017;169(2):181-186. <https://doi.org/10.19206/CE-2017-232>
- [19] Thomas G, Feng B, Veeraragavan A, Cleary MJ, Drinnan N. Emissions from DME combustion in diesel engines and their implications on meeting future emission norms – a review. *Fuel Process Technol*. 2014;119:286-304. <https://doi.org/10.1016/j.fuproc.2013.10.018>

Rafał Smolec, MEng. – Faculty of Civil and Transport Engineering, Poznan University of Technology, Poland.

e-mail: [rafal.smolec@put.poznan.pl](mailto:rafal.smolec@put.poznan.pl)



Maciej Bajerlein, DSc., DEng. – Faculty of Civil and Transport Engineering, Poznan University of Technology, Poland.

e-mail: [maciej.bajerlein@put.poznan.pl](mailto:maciej.bajerlein@put.poznan.pl)



Wojciech Karpiuk, DSc., DEng. – Faculty of Civil and Transport Engineering, Poznan University of Technology, Poland.

e-mail: [wojciech.karpiuk@put.poznan.pl](mailto:wojciech.karpiuk@put.poznan.pl)



Prof. Marek Waligórski, DSc., DEng. – Faculty of Civil and Transport Engineering, Poznan University of Technology, Poland.

e-mail: [marek.waligorski@put.poznan.pl](mailto:marek.waligorski@put.poznan.pl)



Paweł Kril, MEng. – ENVIBRA Sp. z o.o., Poznan, Poland.

e-mail: [pawel.kril@wp.pl](mailto:pawel.kril@wp.pl)

